

AccuForce 12V - 40Ah S

Solar VRLA Battery



Specifications

Nominal Voltage	12 V	
Number of cells	6	
Cycle Life	Approx. 800 cycles at 50% DOD	
Dimensions	Length	197 mm
	Width	165 mm
	Height	170 mm
	Total Height	170 mm
Approx. Weight	12.5 kg	
Nominal Capacity (25°C)	120 hours rate (0.37 A, 11.1 V)	44.4 Ah
	100 hours rate (0.44 A, 11.1 V)	44.0 Ah
	20 hours rate (2.10 A, 10.8 V)	42.0 Ah
	10 hours rate (4.00 A, 10.8 V)	40.0 Ah
	5 hours rate (7.00 A, 10.5 V)	35.0 Ah
Max. Discharge Current (25°C)	400 A (5s)	
Internal Resistance	8.5 mOhms	
Fully Charged battery (25°C)		
Self-Discharge	3% of capacity declined per month at 25°C (average)	
Operating Temperature Range	Discharge	-15°C~50°C
	Charge	-10°C~50°C
	Storage	-20°C~50°C
Short Circuit Current	1410 A	
Charging Characteristics (25°C)	Cycle use	2.40-2.48 Vpc
	Maximum charging current	12 A
	Temperature compensation	-30 mV/°C
	Standby use	2.27-2.35 Vpc
	Temperature compensation	-18 mV/°C

Applications

- Solar / Wind power systems
- Residential installations
- Golf carts and electric powered vehicles
- Marine equipment
- Electric wheelchairs
- Traffic systems (signaling and lighting)
- Remote monitoring and controlling
- Power tools and cleaning machines
- Uninterruptible power supply (UPS)

Battery Construction

Component	Positive Plate	Negative Plate	Container	Cover	Safety Valve	Terminal	Separator	Electrolyte
Raw material	Lead dioxide	Lead	ABS	ABS	Rubber	Copper	Fiberglass	Sulfuric acid

Dimensions

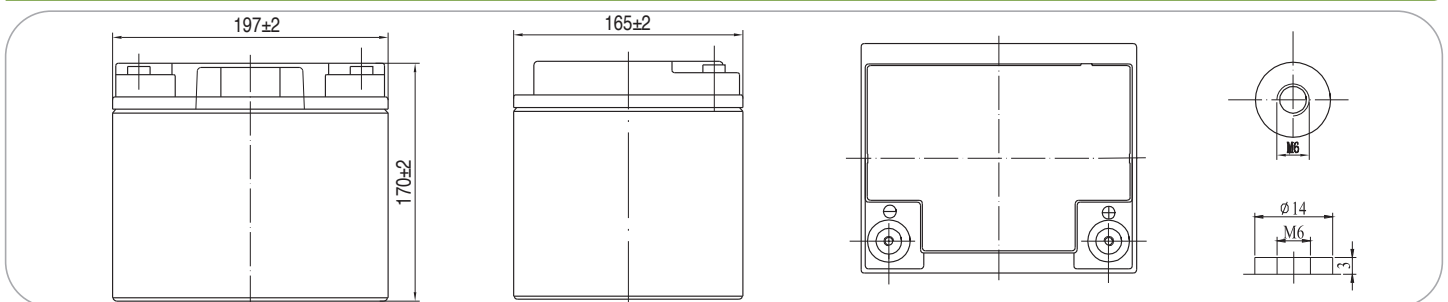

Constant Current Discharge (Amperes) at 25°C

End Voltage (Volts/Cell)	15min	30min	1h	2h	3h	4h	5h	6h	8h	10h	20h	72h	100h	120h
1.60 V	66.8	40.4	25.0	14.6	10.2	8.36	7.16	6.20	4.88	4.08	2.14	---	---	---
1.65 V	65.2	39.6	24.7	14.5	10.2	8.32	7.08	6.12	4.88	4.08	2.13	---	---	---
1.70 V	62.8	38.4	24.0	14.4	10.1	8.24	7.04	6.12	4.84	4.04	2.13	---	---	---
1.75 V	60.4	37.4	23.6	14.2	10.0	8.20	7.00	6.08	4.80	4.04	2.12	---	---	---
1.80 V	57.2	36.1	22.8	13.8	9.72	7.96	6.80	5.88	4.64	4.00	2.10	0.61	---	---
1.85 V	54.3	34.3	21.7	13.1	9.23	7.56	6.46	5.58	4.41	3.80	2.00	0.58	0.44	0.37

Constant Power Discharge (Watts) at 25°C

End Voltage (Volts/Cell)	15min	30min	1h	2h	3h	4h	5h	6h	8h	10h	20h	72h	100h	120h
1.60 V	732	449	284	168	119	97.2	84.0	72.8	58.0	48.4	25.6	---	---	---
1.65 V	714	442	281	167	118	96.8	83.2	72.0	58.0	48.4	25.6	---	---	---
1.70 V	688	429	274	166	118	96.0	82.8	72.0	57.6	48.0	25.5	---	---	---
1.75 V	664	419	269	164	117	95.6	82.0	71.2	57.2	48.0	25.4	---	---	---
1.80 V	630	405	261	160	114	93.6	80.4	69.6	55.2	47.6	25.2	7.28	---	---
1.85 V	599	385	248	152	108	88.9	76.4	66.1	52.4	45.2	23.9	6.92	5.24	4.45

Note: The above characteristics data can be obtained within three charge/discharge cycles.

AccuForce 12V - 40Ah S Solar VRLA Battery

Typical Use Life and Operating Temperature

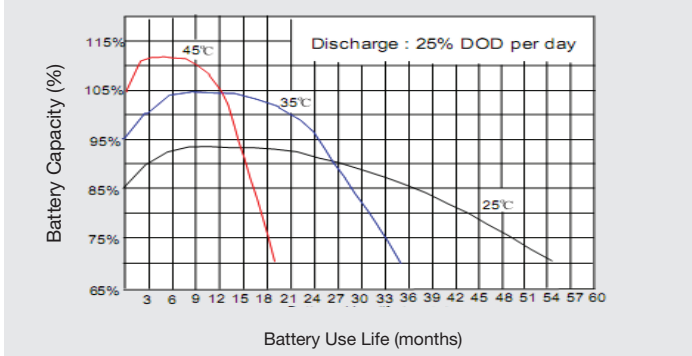

Self Discharge Characteristics

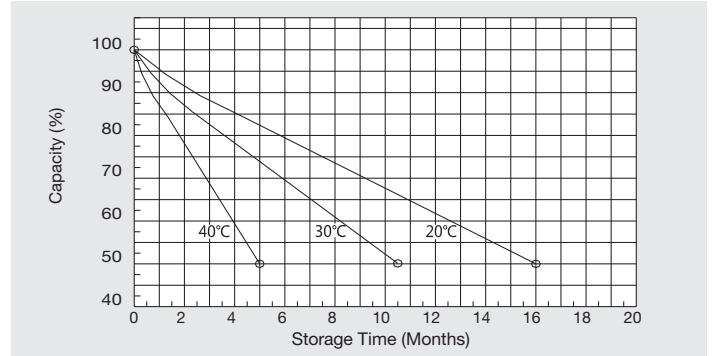

Discharge Characteristics (25°C)

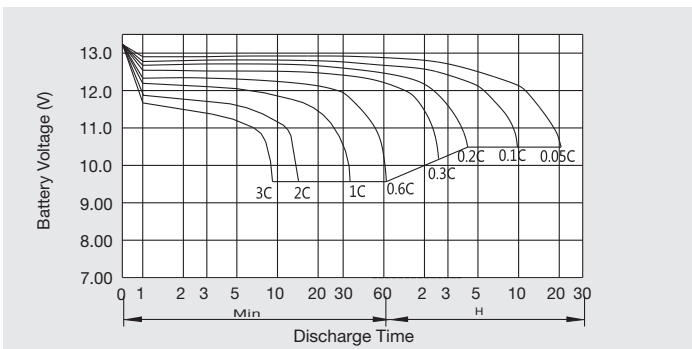

Charging Characteristics (25°C)

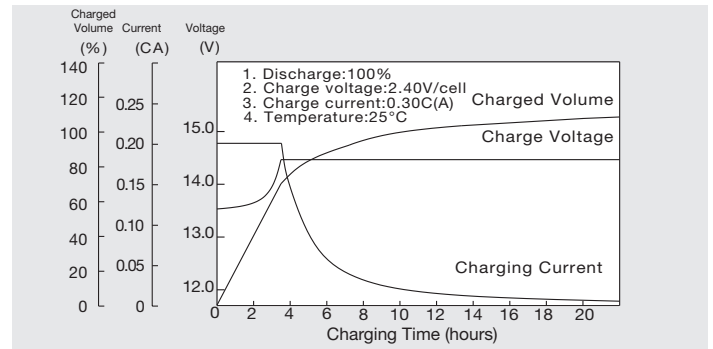

Relationship Between Charging Voltage and Temperature

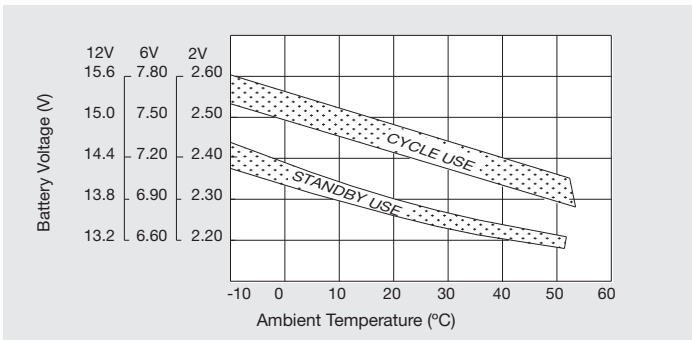

Relationship Between OCV and Residual Capacity (25°C)

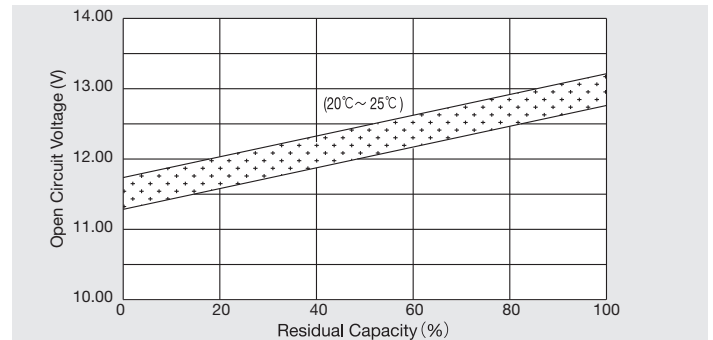

Cycle Service Life in Relation to Depth of Discharge

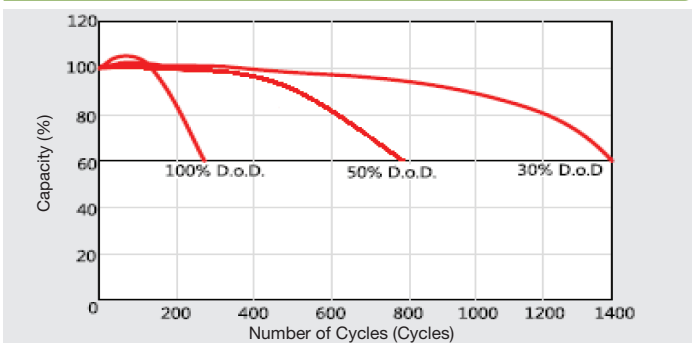

Temperature Effects on Capacity

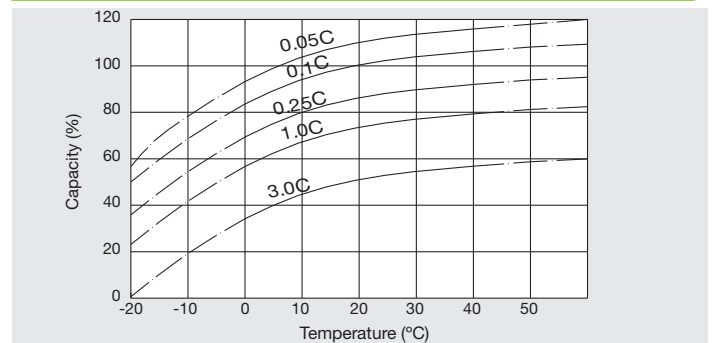

SYSTEMS SUNLIGHT S.A.

Headquarters

2 Ermou & Nikis Str., Syntagma Sq.
105 63 Athens, Attica, Greece

T +30 210 6245400 F +30 210 6245409

European Manufacturing Plant

672 00 Neo Olvio,
Xanthi, Greece

T +30 25410 48100 F +30 25410 95446

Global Service Department

366 Tatoiou Str.
136 73 Acharnes, Attica, Greece

T +30 210 6245600 F +30 210 6245619